

# TRACER LRF

THERMAL IMAGING SCOPE WITH LASER RANGE FINDER

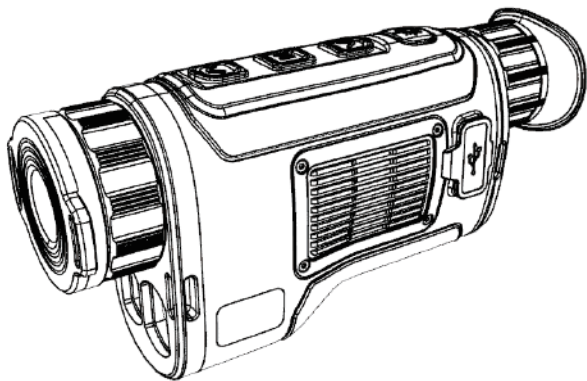
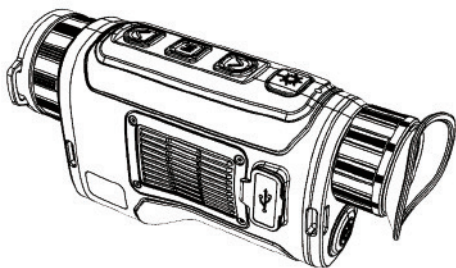

## **Attention!**

Export of *Tracer LRF35/50*,  
*Tracer LRF25/35 Pro* models.  
May have export limitations depending on  
the laws in your region.

RoHS  

## ATTENTION!



The proper usage of the device is important for safe exploitation!  
Therefore read carefully the present manual!



If the device was left in storage for a longer period of time, before exploitation check its functionality.



Disassembling of the device is prohibited, except in authorized repair centers.



The external optical surfaces should be clean at all times. Touching the optical surfaces with bare hands is not recommended.



Sand and sea water can damage the optical coatings!



Do not point the device directly at the sun!



Image performance is dependent on scenery and atmosphere conditions. Contrast in the same image may vary as a function of the time of day due to the effect of the sun. For example, at sunset objects will have absorbed different levels of heat resulting in greater temperature differences and better contrast.



When left in storage for a longer period of time, batteries have to be removed and stored in polyethylene bags to prevent contact with metal. (It is recommended to recharge the batteries every two to three months)



When carrying or transporting the device, put the protective lens cap!



Condensation can cause fogging of the optical surfaces! Condensation occurs when the temperature or humidity changes as follows:

- *When moving the device from cold to warm place or vice versa;*
- *In places with high humidity.*

When equalizing the temperature of the device with the environmental, the condensation disappears. Use the towel to remove moisture.



Clean the lens surfaces with the Lens Cloth or with the napkin!

## LEGAL NOTICE

Before attaching to weapons, check the regional legal regulations in the area of application. The attachment to a weapon is always the sole responsibility of the user.



All images used in this instruction manual are for illustrative purpose only. Actual product may vary due to product enhancement.

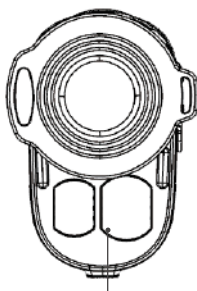
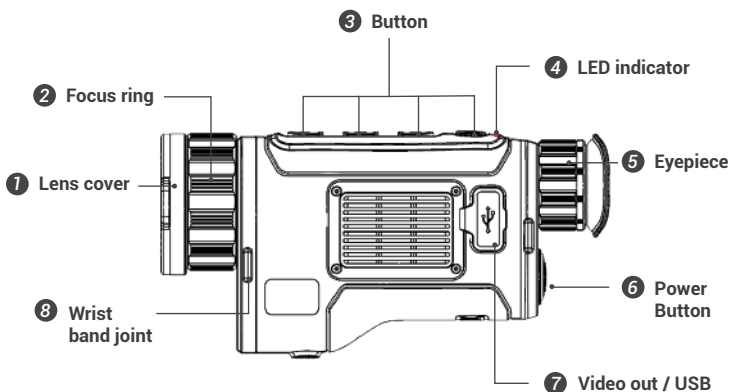

9 Laser rangefinder



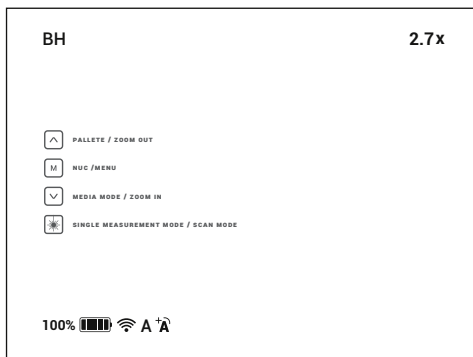





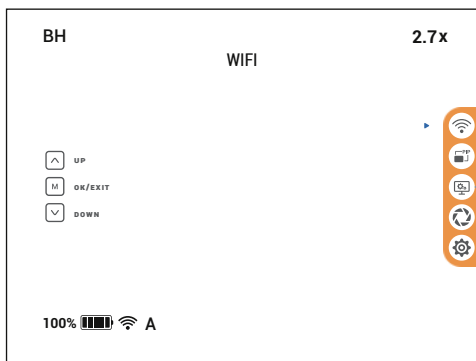

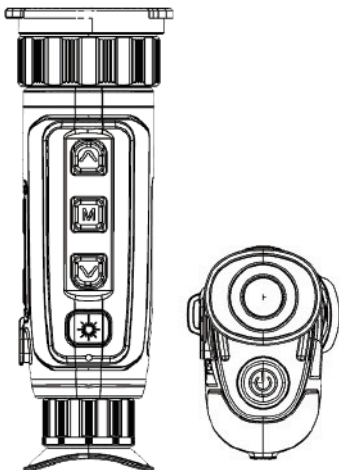

The status display shows information on the actual operating status of the device including:

- Palette ( RB, CG, GB, RH, WH, BH)
- Zoom (35---10.8X, 50---15.6X, 25Pro ---9.6X, 35Pro ---13.2X)
- Help menu
- Battery capacity
- Wifi
- Display modes (A-D)
- NUC mode



Main menu settings icon



	Quick menu		Main menu	
	Short press	Long press	Short press	Long press
	Palette	Zoom -	Up	/
	NUC	Enter menu / Exit menu / Confirm settings	Enter menu / Exit menu/Save	/
	Media mode	Zoom +	Down	/
	Singe measurement	Scan mode switching	/	/
	Stand-by	Turn on / Turn off	Stand-by	Turn on / Turn off
	/	Adjust Brightness	/	/
	/	Adjust Contrast	/	/

## Start up image

Long press of  button for 3 second to power on device.

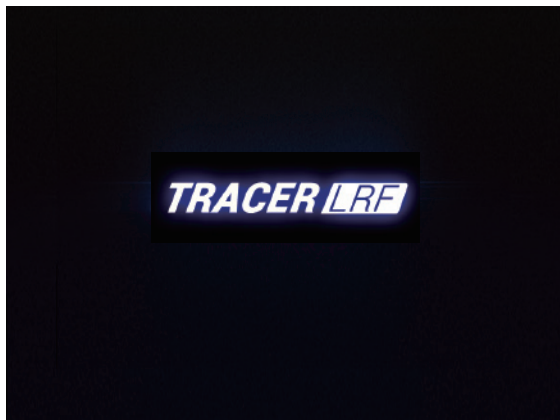

## Power off image

Long press of  button for 3 seconds to power off device.

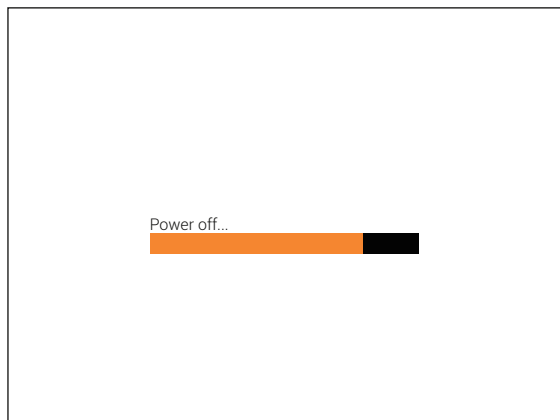

## Palette

Press  button shortly to switch palette from RB, CG, CB, RH, WH, BH.



BH--Black Hot



WH--White Hot



GB--Glowbow



CG--Cold Green





RH--Red Hot



RB--Rainbow

## Zoom

Long Press  or  to have smooth zoom in and out.

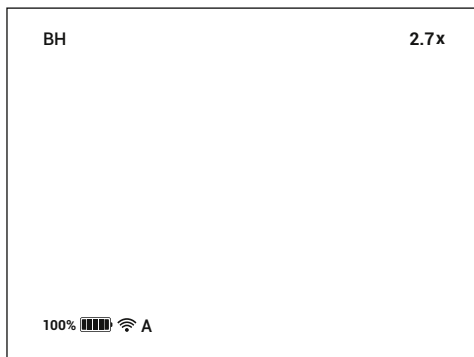

Tracer LRF35 has magnification from 2.7~10.8X.

Tracer LRF50 has magnification from 3.9~15.6X.

Tracer LRF25 Pro has magnification from 2.4~9.6X.

Tracer LRF35 Pro has magnification from 3.3~13.2X.



## NUC

Short press **M** button to act non-uniforming calibration.

## Take photo / video on board

Short press **∨** button, to have multimedia menu display.

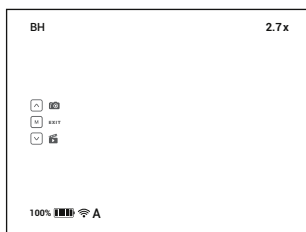

Short press **∧** button, to take photo, number of photo will be shown on bottom screen.

Short press **∨** button, to start/end video recording, recording icon will be shown on bottom screen.

Press **M** button to exit Media mode.

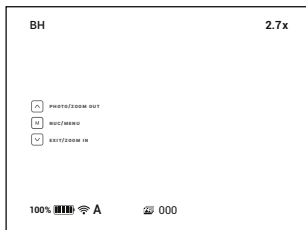
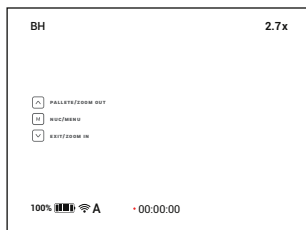

### Please note the following before using :

- When you take photos, do not press too quickly, always wait until 001 disappears before you take 002.
- Please avoid taking photo or videos when device connects with PC. Or else photos or videos are not saved properly.

# Take photo by CONOTECH

User can take photo / video by CONOTECH App.  
Replay on Smart phone.

To get started, install the free CONOTECH App on your mobile device.  
You can search and download at App Store and GooglePlay.



CONOTECH

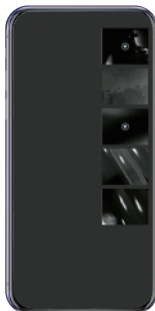
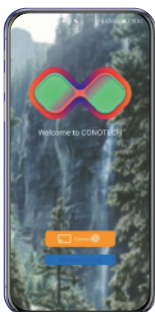

# How to replay on PC ?

- 1.Connect the Micro-usb cable to PC.
- 2.Turn on WIFI and wait 10s.

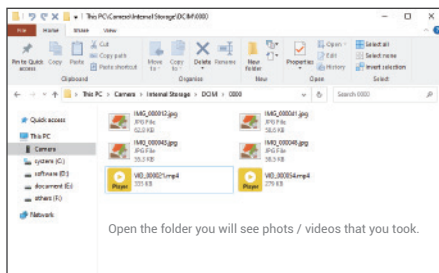
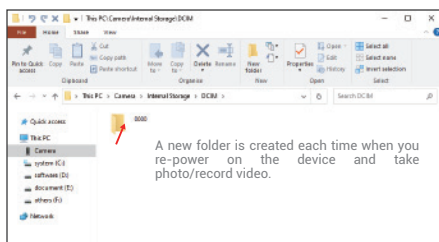
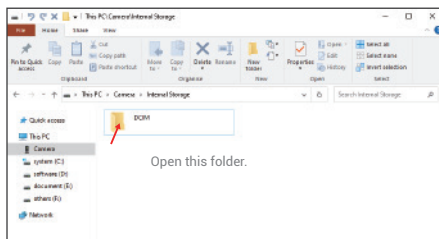
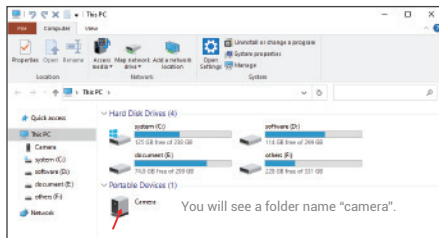

## Laser rangefinder

Short press the  button, the ranging box and distance appear.

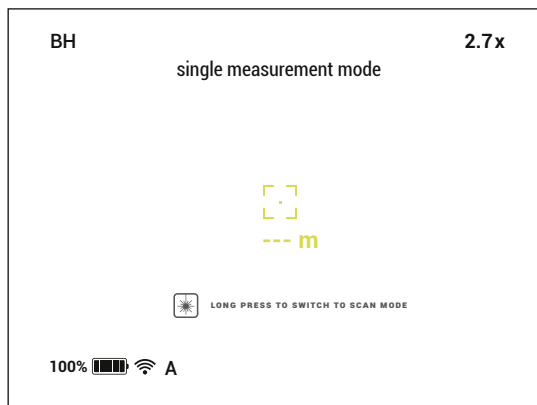

Short press the  button to have range measured once and displayed.

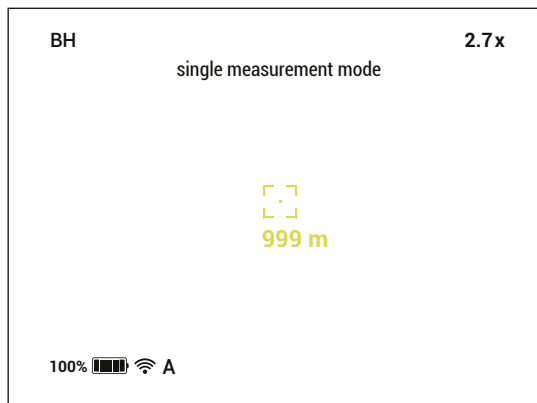

The distance is displayed for 5 seconds then disappear.

Long press  button to start the scan mode, and the scan mode ranging box and distance appear in the real-time image.

Long press  button again to turn off the scan mode. The ranging box and figures will disappear together.

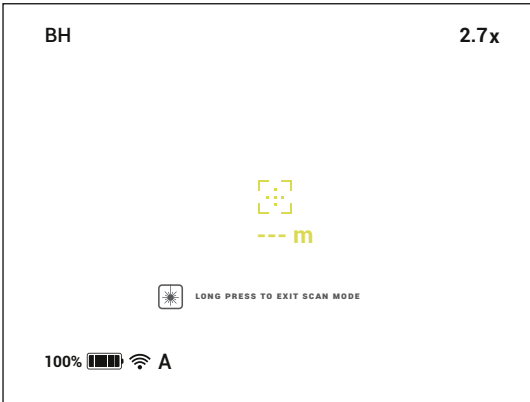

## OPERATING FEATURES:

1. The accuracy and distance of the measurement depends on the reflection coefficient of the object surface and weather conditions. The reflection coefficient depends on the texture, color, size and shape of the object. Generally, lighter colored objects and those with a shiny surface will have a higher reflection coefficient.
2. Measurement accuracy can be influenced by the light conditions, fog, haze, rain, snow, etc. The results may be less accurate when operating in sunny weather or if the rangefinder is directed towards the sun.
3. It is easier and more reliable to measure the distance to large objects than to small ones.
4. The distance of measurement is able to display on your mobile device by CONOTECH App.



When under real time image, long press the M Button to Enter /Exit the main menu.  
Press the M Button to enter Sub-menu/Save.  
Press the Up/Down Button to select between the menu options.

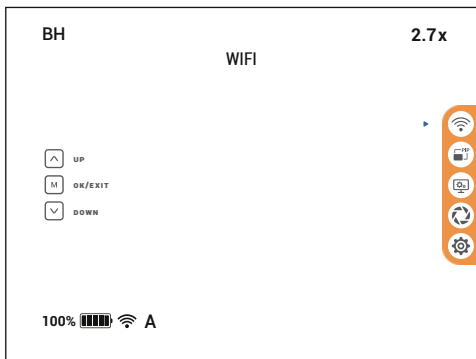

## Wi-Fi

Find Wi-Fi icon from Main menu

Press or button to choose then press button to turn **ON/OFF** Wi-Fi.

Wi-Fi status is shown in the display, means Wi-Fi is off, means Wi-Fi is on.

Find WIFI named:  
Tracer LRF \*\*\*\*\*

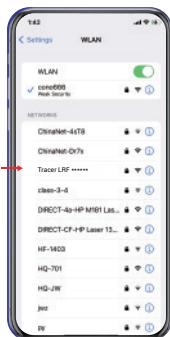



Enter password:  
12345678

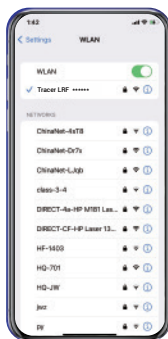

After wait for 10s



## PIP Mode

Press the  or  button then press  button to turn PIP Mode **On / Off**.

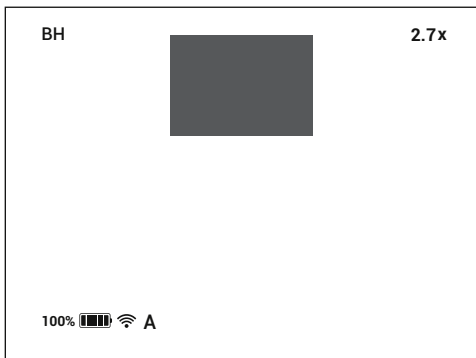



## Display setting

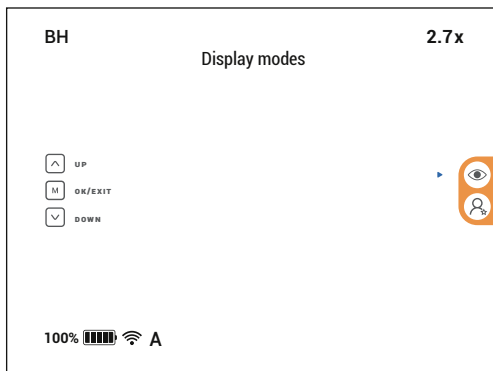

### Display modes:

- A ... Normal
- B ... Booster
- C ... Stroke
- D ... Enhance





## User mode

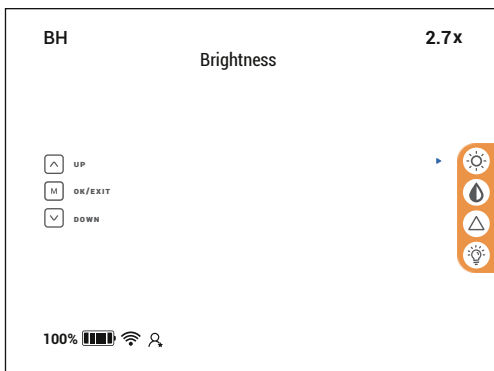

### Brightness

Press the or buttons to change image brightness from 1~5.

You can also enter Brightness adjustment by long press both and buttons in the real image.



### Contrast

Press the or buttons to change display contrast from 1~5.

You can also enter Contrast adjustment by long press both and buttons in the real image.



### Sharpness

Press the or buttons to change sharpness from 1~5.





### OLED Brightness

Press the or buttons to change OLED brightness from 1~5.

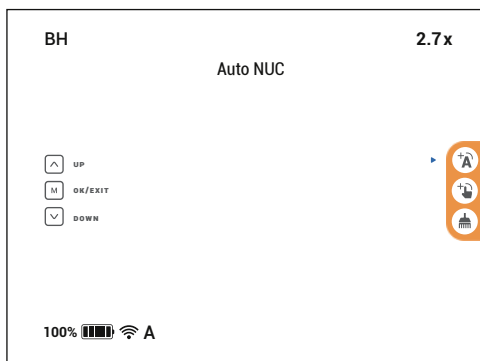
## Calibration setting



### Auto NUC

Press the  or  button then press  button to turn Automatic Calibration **On / Off**.

In the Automatic Calibration mode, The device is calibrated autonomously according to firmware algorithms.

There is no need to close the lens cover.



### Manual Calibration

Press  buttons, prompt to close the lens cover, and complete after counting down **3-2-1**.



### Defective Pixel Repair

Press  buttons, prompt to close the lens cover, and complete after counting down **3-2-1**.

Defective pixels are found by software algorithm.



## System setting

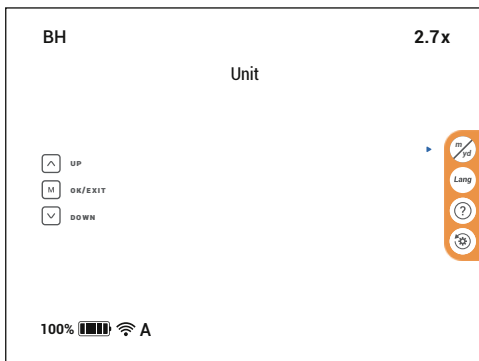

### Unit

Press  or  to select units of measurement from Yards and Meters, then press  button to confirm.



### Language

Press  or  to select language, then press  button to confirm.



### Help

Press the  or  button then press  button to turn help **On / Off**.



### Reset the factory setting

Press  or  buttons to Restore Default Setting. (All your parameters will be default)

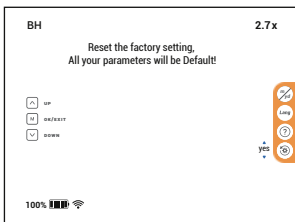

**The Tracer LRF series comes with built-in rechargeable Lithium-ion battery. Before first use, make sure the battery is fully charged.**

Power supply / Firmware update

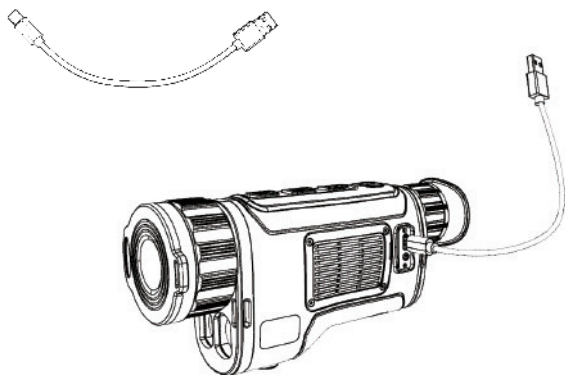

When charging the LED light will be in red color.

When battery is fully charged LED light will be in green color.



**Attention**

It is not recommended to use when charging, which will shorten the battery life.

Charging batteries from an external source at temperatures below 0°C can reduce battery life.

When using external power, connect the Power Bank to the device only after it has been turned on and working for at least several minutes.

Video Cable



Video cable serves for external displaying

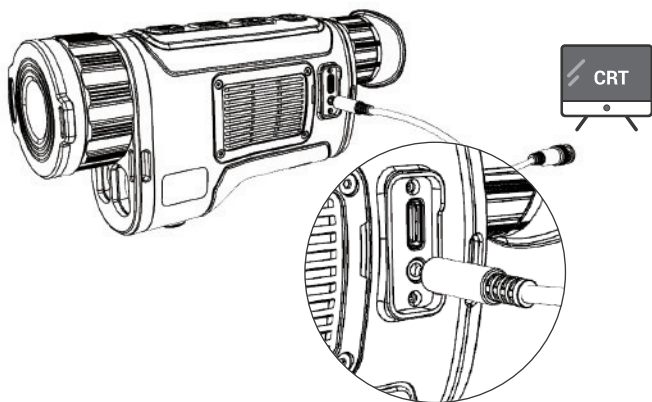

- Before storing it, clean obligatory the device (if on its surface there are moisture, dust or traces of dirt)!
- Make sure that there are no traces of moisture, and the battery compartment is empty!
- It is also possible for a short periods of time device to be stored in a suitable soft pack, bag or cartridge box.
- The premises in which the device is kept for long term have to be dry, enclosed, unheated and ventilated.
- During the storage should not be allowed exposure to aggressive environments, temperatures below  $-50^{\circ}\text{C}$  and above  $+60^{\circ}\text{C}$ , relative humidity greater than 80%, and prolonged periods of direct sunlight.
- Before each transportation, the product should be neatly packed in its original packaging (transport bag) and all other items and accessories should be carefully and steadily placed in the bag. After that the bag should be steadily placed in the transport suitcase.
- You can ship the product with all types of transport at different distances and at altitude up to 12 000 m.

### Technical Data Sheet

	TracerLRF 35	TracerLRF50	TracerLRF 25 Pro	Tracer LRF 35 Pro
<b>Detector</b>				
Type	Uncooled Vox		Uncooled Vox	
Resolution	384×288		384×288	
Frame rate	50Hz		50Hz	
Pitch	17μm		12μm	
Spectral range	8-14μm		8-14μm	
NETD	30mk		30mk	
<b>Optical Characteristics</b>				
Objective lens	35mm	50mm	25mm	35mm
Magnification	2.7x	3.9 x	2.4X	3.3X
FOV	10.6°×8.0°	7.4°×5.6°	10.6° X 7.9°	7.5°×5.7°
Close-up range	5m		5m	
Dioptr adjustment	-5D-4D		-5D-4D	
<b>Functions</b>				
Zoom	1X/2X/4X		1X/2X/4X	
Palette	6 optional(can be customized)		6 optional(can be customized)	
Start up time	Less than 5 seconds		Less than 5 seconds	
Image enhancement	DDE		DDE	
Contrast and brightness	AGC		AGC	
Online update	Both code and GUI resources		Both code and GUI resources	
<b>Display</b>				
Type	OLED		OLED	
Resolution	1024×768		1024×768	
<b>Power Supply</b>				
Battery	Built-in lithium battery		Built-in lithium battery	
External power supply	5V micro USB		Type-C USB	
Battery life	8h+		8h+	
<b>Physical Characteristics</b>				
Weight without battery	540g	590g	530g	540g
Size	155x50x92mm	165x56x92mm	153x50x92mm	155x50x92mm
<b>Physical Characteristics</b>				
Water proof	IP67		IP67	
Operating temperature	-20℃-50℃		-20℃-50℃	
Storage temperature	-40℃-60℃		-40℃-60℃	
<b>Physical Characteristics</b>				
Safety class for laser equipment according to IEC 60825-1:2014	1		1	
Measuring range	5-1000m		5-1000m	
Measurement accuracy	±1m		±1m	

**CONOTECH**

Hubei CONO Technology Co., Ltd  
Tel/ Fax:0086-27-87137247  
Email: Support@cono-tech.com

[www.cono-tech.com](http://www.cono-tech.com)